

## Performance Analysis and Comparison between the Uncoded OIDMA and Convolutional Coded OIDMA

Tushar Srivastava<sup>1</sup>, Dr. Anil Kumar<sup>2</sup>, Arvind Kumar Jaiswal<sup>3</sup>

Department of Electronics and communication Engineering Sam Higginbottom Institute of Agriculture,  
Technology and Sciences, Allahabad, Uttar Pradesh, India-211007

<sup>1</sup>PG Student, <sup>2</sup>Asst. Prof., <sup>3</sup>Prof.

**Abstract :** Convolutional coding technique is a low rate coding technique. Optimum multiple channel capacity is achievable only when entire bandwidth is devoted to coding. For maximizing the coding gain the combination of two operations coding and spreading using low rate codes are done. The implementation of convolutional codes in an optical IDMA system provides significant improvement in system performance. Optical interleaved division multiple-access (OIDMA) scheme inherits the advantage of both Optical system and IDMA technique. For pulse propagation in optical fiber, the nonlinear linear Schrödinger equation (NLSE) is used. On-Off keying (OOK) is used for pulse transmission. It is demonstrated that Convolutional Coded optical IDMA has better bandwidth utilization and less multiple access interference. Convolutional Coded Optical IDMA technique shows that high performance can be maintained with large number of users.

**Keywords:** Convolutional Codes, Interleavers, Optical IDMA, On-Off keying, Turbo code.

### I. Introduction

Coding theory is the branch of communication theory that deals with mathematical study of codes with a view to their employment in communication system [6], usually for the purpose of increasing their efficiency and reliability [3]. Coding theory is one of the most important and direct application of information theory [10]. The main aim of coding theory is to provide secure transmission of message, in the sense that (up to certain number of) errors that occurred during the transmission can be corrected. Codes are used for data compression, error-correction. It can be sub divided into source coding theory and channel coding theory.

1. Data compression (or, source coding)
2. Error correction (or, channel coding)

Channel coding is the theory by which codes can be constructed to detect and correct errors [10]. Such errors may be caused by transmission channels and noise. Channel coding use of error- detecting or error-correcting codes in order to achieve reliable communication through a transmission channel. In channel coding, the particular code to be used is chosen to match the channel (and especially its noise characteristics), rather than the source of the information. These codes are called channel code. Channel codes introduce redundancy into the information sequence so that it is possible to correct erroneous symbols altered by the channel and thus ensure reliable transmission. For this reason, channel codes are often referred to as error correcting codes. Errors in a digital communication system can be reduced by using some popular error-control coding techniques. These are automatic repeat request (ARQ), forward error correction (FEC), hybrid ARQ, interleaving, erasure decoding, and concatenation. Forward error correction is appropriate for applications where the user must get the message right the first time. The one-way or broadcast channel is one example. Today's error correction codes fall into two categories: block codes and convolutional codes.

### II. Optical IDMA System

Here, we consider an IDMA system, show in figure 2, with  $k$  simultaneous user using a single path channel. At the transmitter, a  $n$  length input data sequence  $d_k = [d_k(1), \dots, d_k(i), \dots, d_k(N)]^T$  of user  $k$  is encoded into chips  $c_k = [c_k(1), \dots, c_k(j), \dots, c_k(J)]^T$  based on low rate code  $C$ , where  $J$  is the chip length. The chip  $c_k$  is interleaved by a chip level interleaver ' $\pi_k$ ', producing a transmitting chip sequence  $x_k = [x_k(1), r_k(j), \dots, r_k(J)]^T$ . After transmitting through the channel, the bits are seen at the receiver side as  $r = [r_k(1), r_k(j), \dots, r_k(J)]^T$ . The channel is additive white Gaussian noise (AWGN) channel, for simulation purpose. In receiver section, after chip matched filtering, the received signal from the  $k$  user can be written as

$$r(j) = \sum_{k=1}^K h_k x_k(j) + n(j), j = 1, 2, \dots, J \quad \dots \dots \quad (2.1)$$

Where  $h_k$  is the channel coefficient for user- $k$  and  $\{n(j)\}$  are samples of an AWGN process with zero mean and variance  $\sigma^2 = n_0 / 2$ , Assuming that the channel coefficient  $\{h_k\}$  are known a priori at the receiver.

The receiver consist of an elementary signal estimator (ESEB) and bank of k single user a posteriori probability (APP) signal decode SDECs, operating and iterative manner. The modulation technique is used for modulation is binary phase shift keying (BPSK) signaling.

The outputs of the PSE and DEC are extrinsic log-likelihood ratios (LLRs) about  $e(x_k(j))$  defined below as;

$$e(x_k(j)) = \log \left( \frac{P(x_k(j)=+1)}{P(x_k(j)=-1)} \right) \text{ for all } k, j \quad \dots\dots\dots(2.2)$$

Those L L R s are further distinguished by subscripts, i.e.  $e_{PSE}(x_k(j))$  and  $e_{DEC}(x_k(j))$ , depending on whether they are generated by the PSE or DEC

Due to the use of random interleaver  $\{\pi_k\}$ , the PSE operation can be carried out in a chip-by-chip manner, with only one sample  $r(j)$  used at a time. So, rewriting to as –

$$r(j) = h_k x_k(j) + \varepsilon_k(j) \quad \dots\dots\dots(2.3)$$

Where  $\varepsilon_k(j) = r(j) - h_k x_k(j)$

$\varepsilon_k(j)$  is the distortion (including interference-plus-noise) in  $r(j)$  with respect to user-k. A brief description of CBC algorithm used in IDMA, has been presented in [3], the operation of ESEB and APP decoding are carry out user by user. The output of ESEB and extrinsic log likelihood ratios (LLRs) is given as

The LLR out of SDEC is given as –

$$e_{SDEC}(x_k(\pi(j))) = \sum_{j=1}^S e_{ESEB}(x_k(\pi(j))) ; j = 1 \dots, S \quad \dots\dots(2.4)$$

$$e_{SDEC}(x_k(j)) = 2h_k \frac{r(j) - E(r(j)) + h_k E(x_k(j))}{Var(r_j) - |h_k| Var(x_k(j))} \quad \dots\dots\dots(2.5)$$

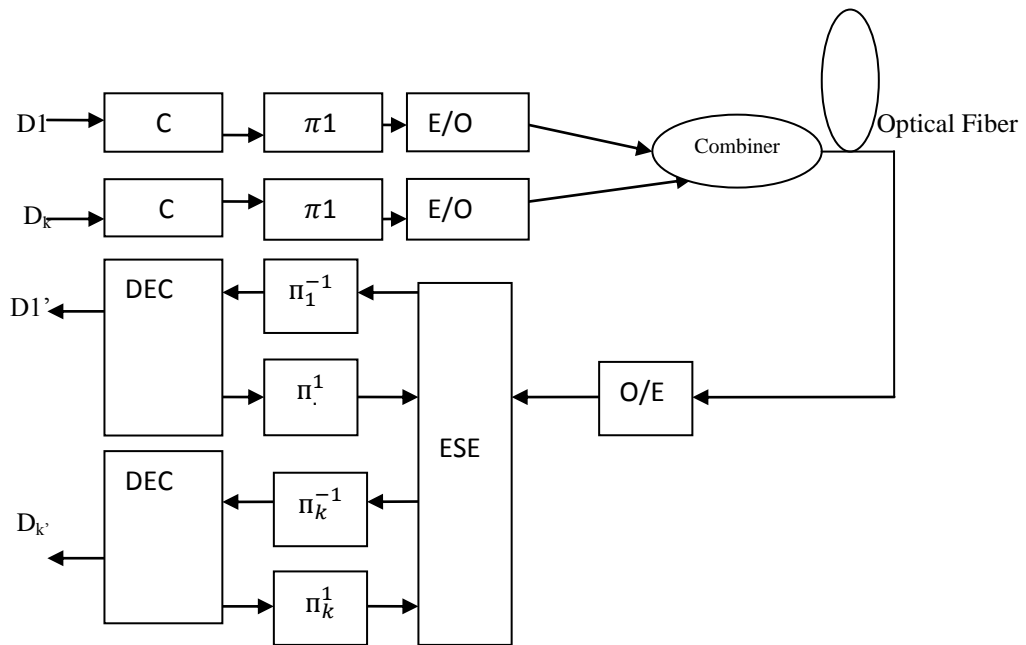

Figure2 Optical IDMA System

### III. Convolutional Coding

A convolutional code contains memory, that is, a convolutional encoding process is dependent on both the current and the previous message inputs [7]. Because of this, a convolutional code is specified by three parameters: the codeword length  $n$ , the message length  $k$ , and the constraint length  $\nu$  defined as the number of previous messages involved,  $M$ , plus 1. So, an  $(n, k, \nu)$  convolution code involves not only the current message but also  $\nu - 1$  previous ones. The parameter  $M$  refers to the memory depth of the code.

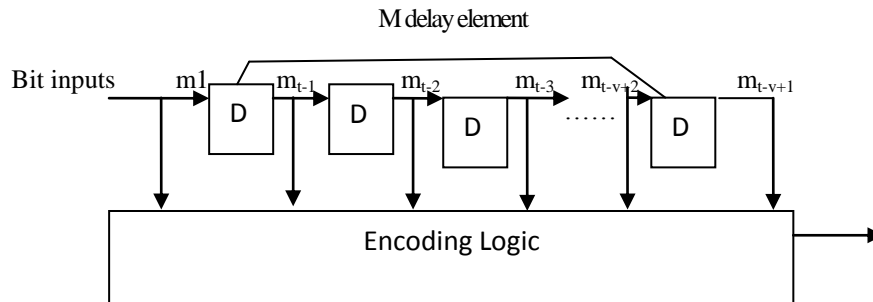

Figure 3 Structure of binary convolutional encoder

For an  $(n, 1, v)$  binary convolutional code, the message input to the encoder is a binary sequence. Upon receiving an input bit  $m_t$  at time  $t$ , the encoder produces an  $n$ -bit codeword  $C_t = (c_t^{(1)} . c_t^{(2)} \dots \dots c_t^{(n)})$

$$c_t^{(j)} = \sum_{i=0}^{v-1} g_i^{(j)} \oplus m_{t-i} \dots \dots \dots (3.1)$$

Where  $j=1,2,3, \dots \dots n, g_i^{(j)} \in \{0,1\}$  are the coefficients. These coefficients constitute the encoding logic of the encoder.

#### IV. Code Termination

To encode a message sequence, we need a starting point. This starting point is the encoder initial state and is usually set to be the all-zero state. However, at the end of the encoding process, the encoder state is usually unknown. On the other hand, an optimum decoder needs to know the encoder final state to decode. As such, it is necessary to force the encoder to a Known state when the encoding process comes to an end (this is what code termination is all about). Several methods exist for doing this. Among them the zero-tailing and tail-biting methods are the two most popular ones. The zero-tailing method appends a "tail" of  $M$  zeros ( $M$  is the memory depth of the encoder) to the message sequence, so that at the end the encoder memory contains only zeros and the encoder is at the all-zero state. We have in fact done this implicitly. Going back to the actual message bits of the encoder input sequence in the example are 1 1 0 1, and two zeros are purposely added at the end of the sequence in order to let the encoder (with the memory depth  $M = 2$ ) go back to the all-zero state. We split state  $S(00)$  into a starting state and an ending state, implying that the ending state is also  $S(00)$ . The  $M$  zeros are often called flushing bits, meaning that they are used to clear the encoder memory.

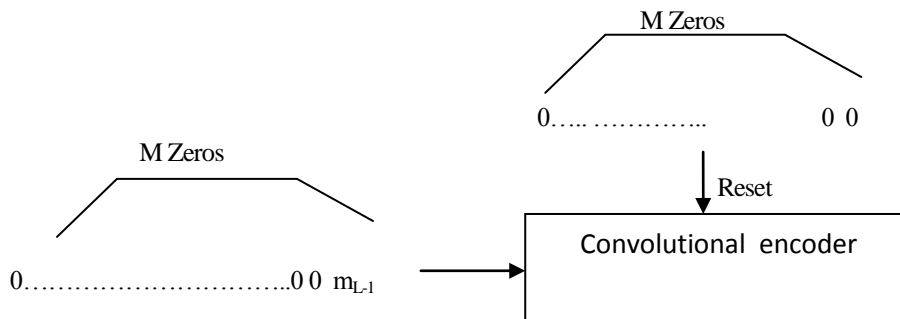

Figure 5(a) Zero-tailing method

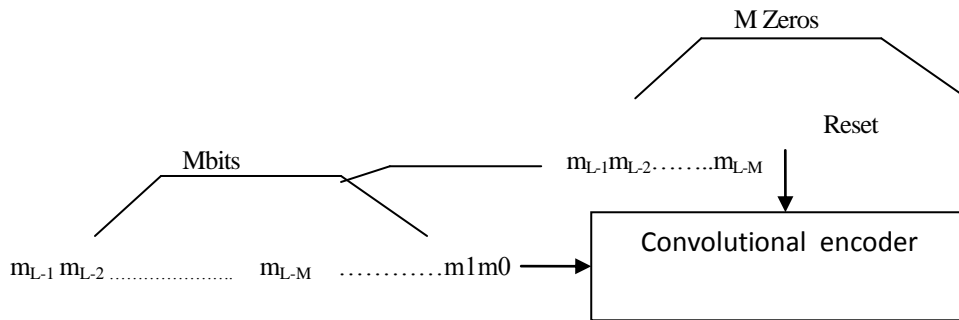

Figure 5(b) Tail-biting method

The method is simple to implement, but, due to addition of the extra bits, the effective coding rate is reduced to  $R \cdot l / (l + M)$ , where  $l$  is the length of the actual message sequence, and  $R$  is the original coding rate. The tail-biting method Fig5(b) solves the problem by initially setting the encoder to a state that is identical to its final state rather than to the all-zero state. The encoding process then proceeds as follows: First, use the last  $M$  bits of the message sequence to initialize the encoder, and then input the message sequence to the encoder to perform the encoding as usual. At the end of encoding, the same  $M$  bits terminate the encoder.

### V. Results

Figure 6(a),(b),(c),(d) shows BER performance of optical IDMA in optical channel with different numbers simultaneous users. During the simulation, the spreading length is chosen as 16, and the iterative number is set to be 10. The variation is user count and BER has been opted as parameter of performance has been displayed in the figure during performance comparison to uncoded Optical IDMA system and Convolutional Coded Optical IIDMA. For simulation purpose, the input data for each user is assumed to be as 512, 1024 bits. Optical fiber has been operated with 1550 nm wavelength with maximum bit rate of 1Gbps capability. The transmitted power is chosen to be 1mW, while intensity dependent refractive index parameter is  $2 \cdot 10^{-20}$ . The responsively and efficiency is 0.65, 0.80 has been taken respectively. The input to optical fiber is a Gaussian pulse and ON-OFF keying. (OOK) is used for pulse transmission. The simulations have been performed at coding rate 1/3 and coding rate 1/2.

For Data length  $M=512$ , Coding rate 1/3 and various numbers of users ( $n= 40$  to 160):

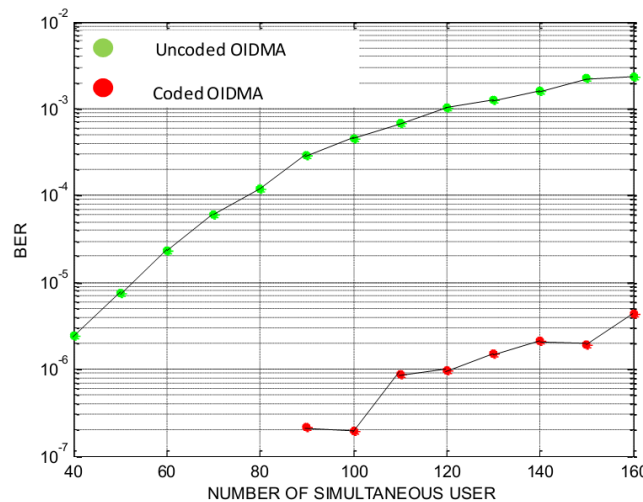

Figure6 (a) BER performance of uncoded Optical IDMA and coded OIDMA at data length 512, coding rate 1/3.

For data length  $M=512$ , coding rate  $1/2$  and various numbers of users ( $n=40$  to  $160$ )

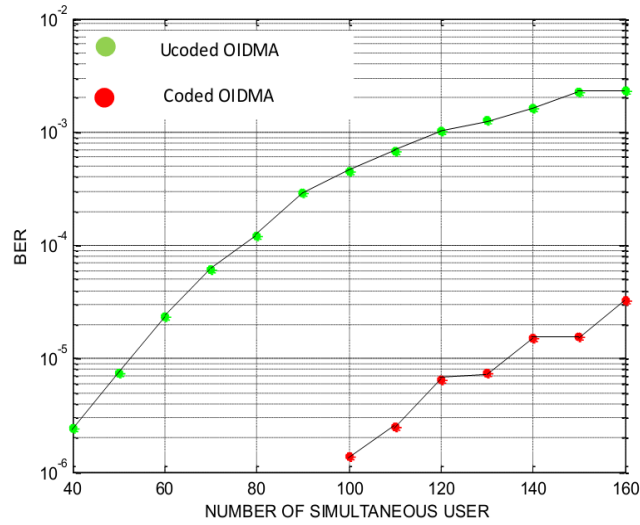

Figure 6 (b) BER performance of uncoded Optical IDMA and coded OIDMA at data length 512, coding rate  $1/2$ .

For data length  $M=1024$  coding rate  $1/3$  and various numbers of users (40 to 160)

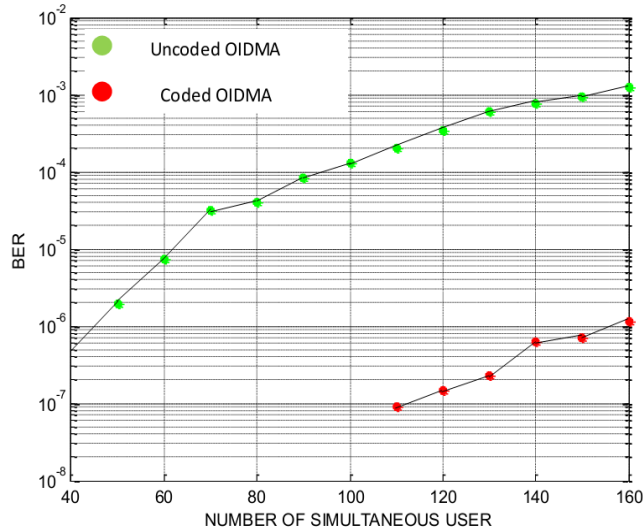

Figure 6(c) BER performance of uncoded Optical IDMA and coded OIDMA at data length 1024, coding rate  $1/3$

For data length  $M=1024$ , coding rate  $1/2$  and various numbers of users (40 to 160)

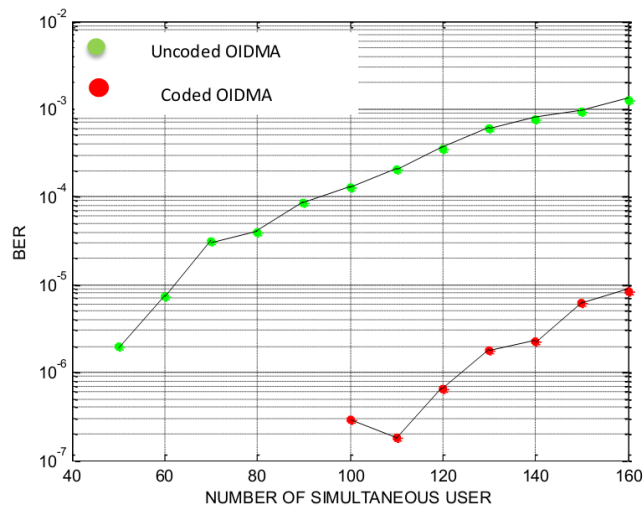

Figure 6 (d) BER performance of uncoded Optical IDMA and coded OIDMA at data length 1024, coding rate  $1/2$

## **VI. Conclusion**

Convolutional Coded OIDMA system provides an efficient and effective solution to high rate multi user optical communication. The low complexity and high performance properties make the IDMA scheme a competitive candidate for next generation optical communication system. IDMA has been chosen as one of the main multiple access schemes for 4G systems. The focus of this paper has been concentrated on Interleave Division Multiple Access Scheme (IDMA). Convolutional encoded OIDMA gives the better results as compared to without encoded OIDMA at various data length (i.e. 512, 1024) and various users (i.e. 40,50,.....,160). Convolutional coded OIDMA gives the better results at data rate  $1/3$  as compared to  $1/2$ .

Thus at last it can be concluded that OIDMA system with Convolutional encoding technique is an efficient solution of high data rate, less multiple access interference, cost independent of number of users and other recommendation of International Telecommunication Union (ITU): It has become one of the main candidate for 4G system.

## **References**

- [1]. M.Shukla, Monika Gupta, Shashi Tiwari and P.K.Sharma "Optical Interleave Division Multiple Access Scheme for long Distance Optical Fiber Communication", in proc.2010 IEEE International Conference on Computational Intelligence and Computing Research, ICCIC-2010, pp.260-263, December 28-29, 2010.
- [2] Li Ping, Lihai Liu, Keying Wu, W. Leung, "Interleave Division Multiple Access" IEEE Transactions On Wireless Communications", Vol. 5, No. 4, pp. 938-947, April 2006.
- [3] I. Pupeza, A. Kavcic, and L. Ping, "Efficient generation of interleavers for IDMA," in Proc. IEEE International Conference on Communications, ICC 2006, vol. 4, pp. 1508-1513, June 2006
- [4] T.Mizuochi, "Recent progress in forward error correction and its interplay with transmission impairments," IEEE J. Sel. Topics Quantum Electron., vol. 12, no. 4, pp. 544- 554, Jul. 2006.
- [5] D. J. Costello, Jr. and G. D. Forney, Jr., "Channel coding: The road to channel capacity," Proc. IEEE, vol. 95, no. 6, pp. 1150-1177, Jun. 2007.
- [6] Yeon Ho Chung, "Performance and bandwidth efficient interleave-division multiple access scheme with high-spaced interleavers in Proc. 6th International Conference on Information communications & signal processing, pp 1-5 ,2007.
- [7] J.Hagenauer, E.Offer, L.Papke, "Iterative decoding of binary block and convolutional codes", IEEE Transactions on Information Theory, vol 42, No. 2, pp. 429-445, March 1996.
- [8] C.Berrou, A.Glavieux, P.Thitimajshima, "Near Shannon limit error-correcting coding and decoding: Turbo codes ", International Conference on Communications, IEEE, vol. 2/3, pp. 1064-1070, May 1993.